

フタ本体

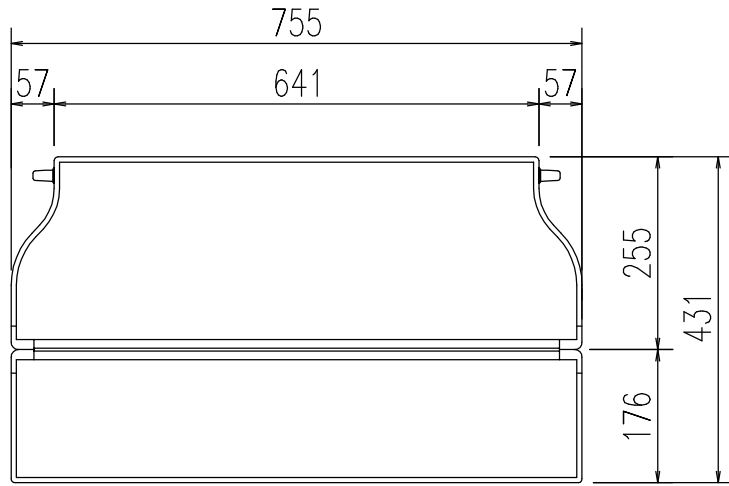

固定部品L (S=1/5)

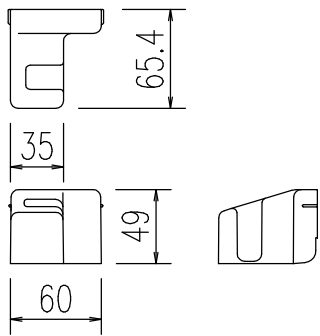

固定部品R (S=1/5)

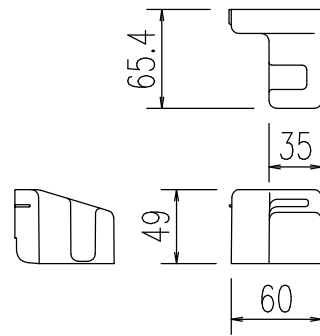

ダボ (S=1/1) ... 4個

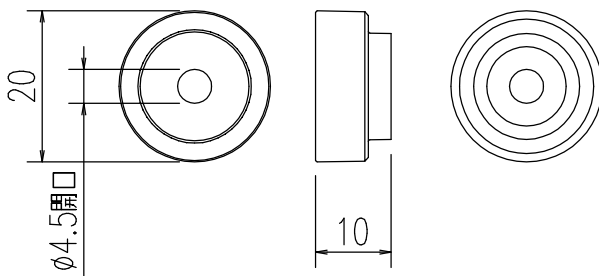

ダボカバー (S=1/1) ... 4個

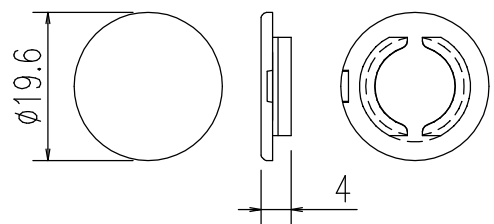

M4小ねじ (S=1/1) ... 4個

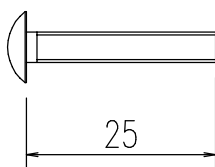

ワッシャー (S=1/1) ... 4個

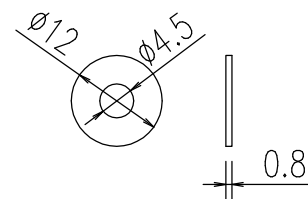

特記事項	品名	図面	担当	検図	図番
	組蓋				日付
	品番	尺度	株式会社 LIXIL		
	YFK-0476A(1)-D-B	1/10			